

# Data Sheet



Article number: 586350312

Description: Ball Valve 350.312, G 1" - G 1"  
Thread/Thread

## Measures

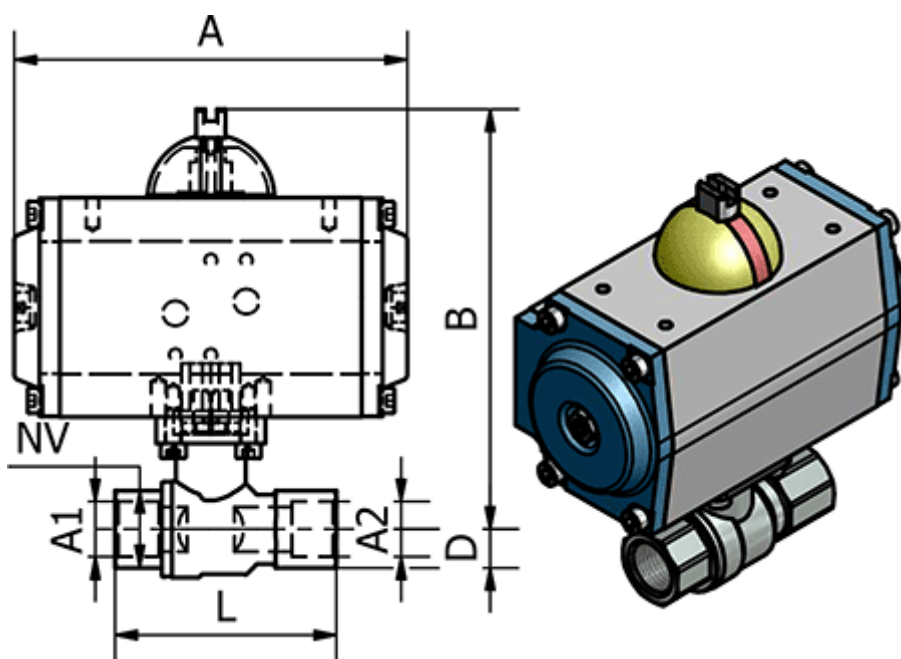

A	= 133
B	= 148
Connecting A1	= G 1"
Connecting A2	= G 1"
D	= 25
L	= 90
Max. Operating Pressure	= 40 bar
NV	= 41